

ESQUEMA GENERAL

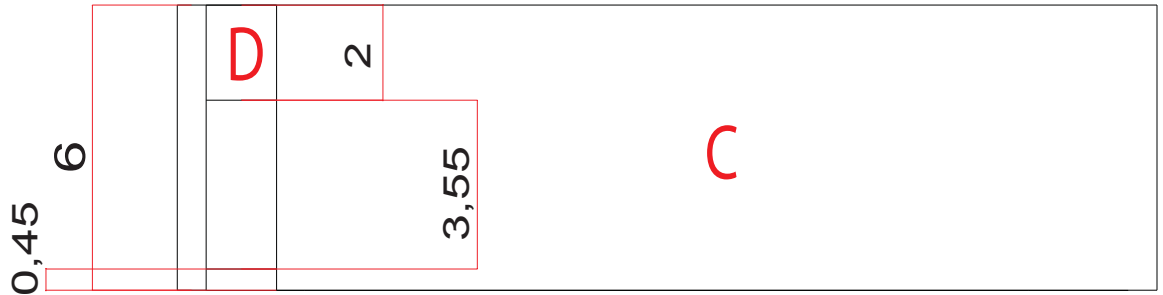
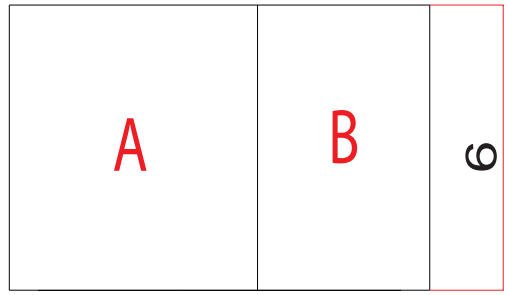
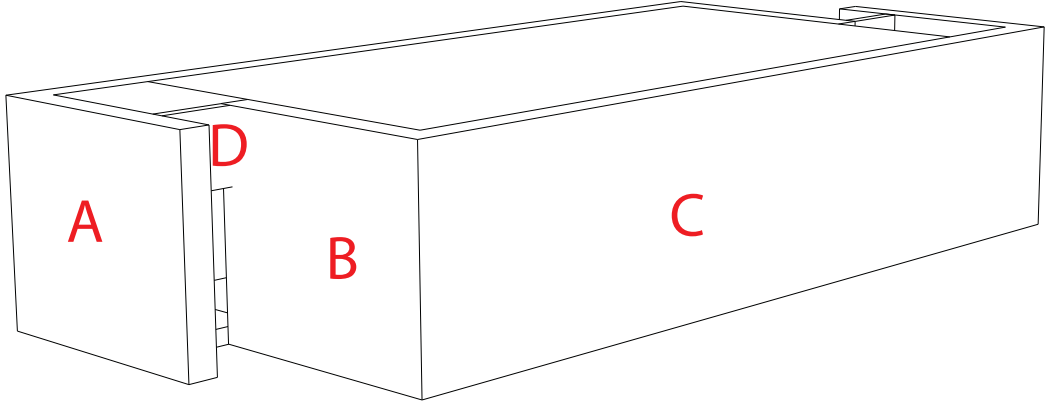
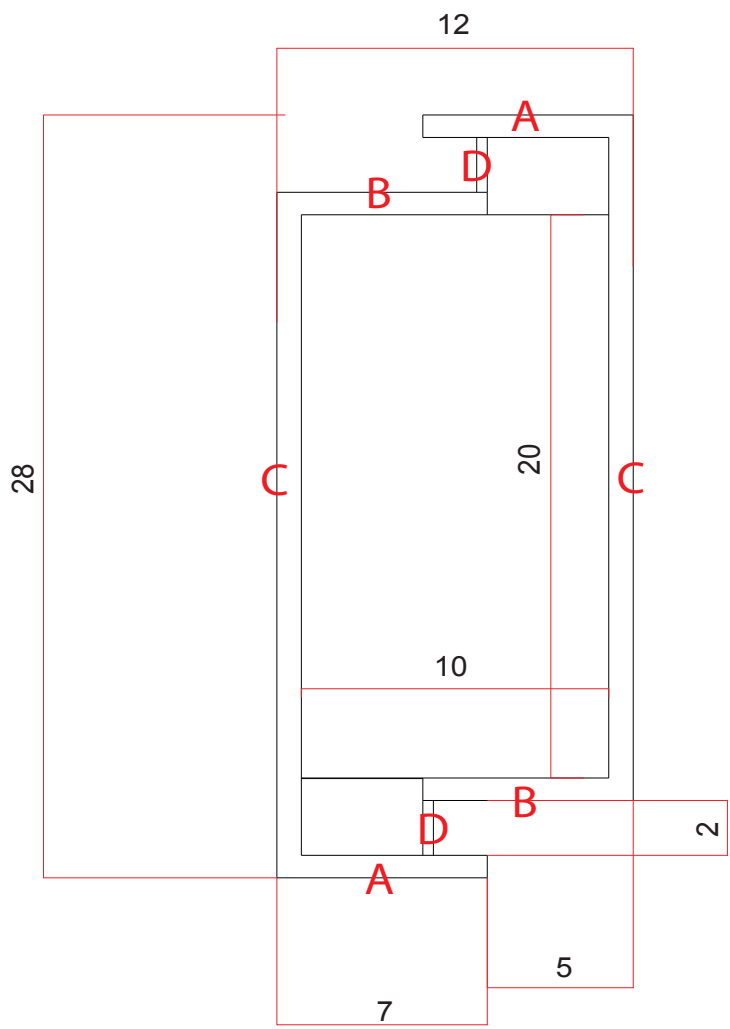

CENEFAS

PERFIL T , CONFORMADO POR DOS PERFILES L , UNIDOS POR SOLDADURA DE PUNTO.

TERMINACIÓN SUPERFICIAL: CONVERTIDOR DE OXIDO - COLOR

ESPESOR: CHAPA DEL 20

CANTIDAD: 380 UNIDADES

ESQUINEROS CON ENCUENTRO A 45.

CANTIDAD: 28 UNIDADES

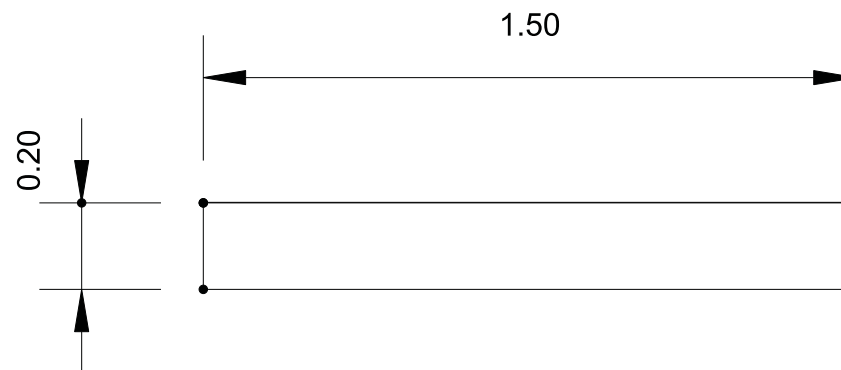
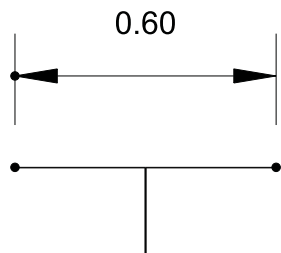
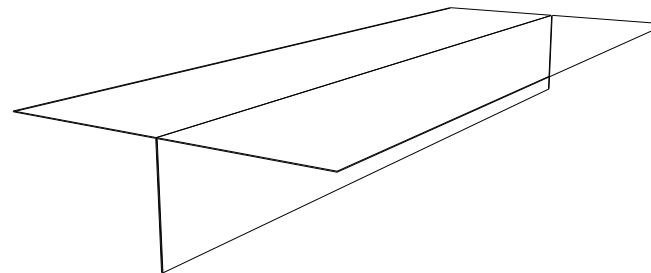
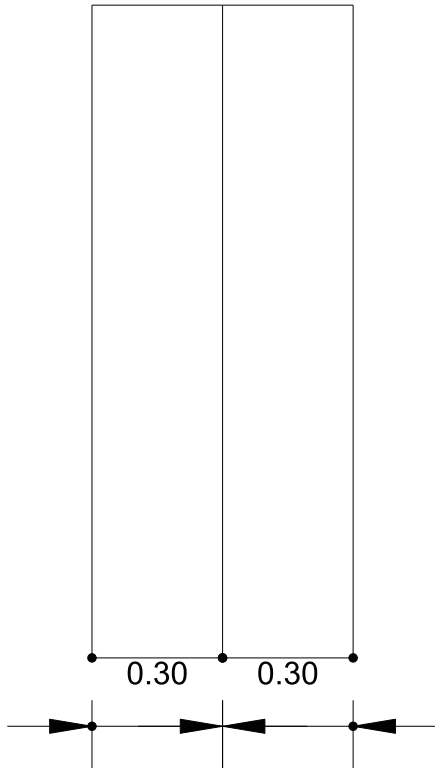

DEPOSITO

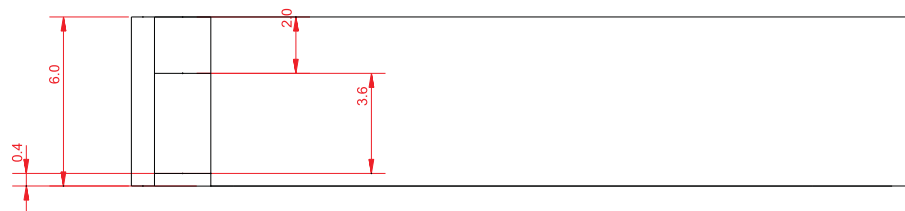
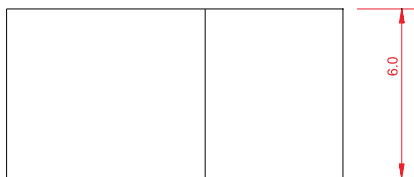
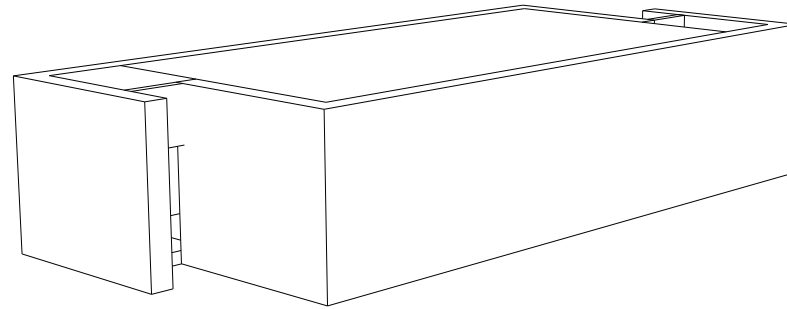
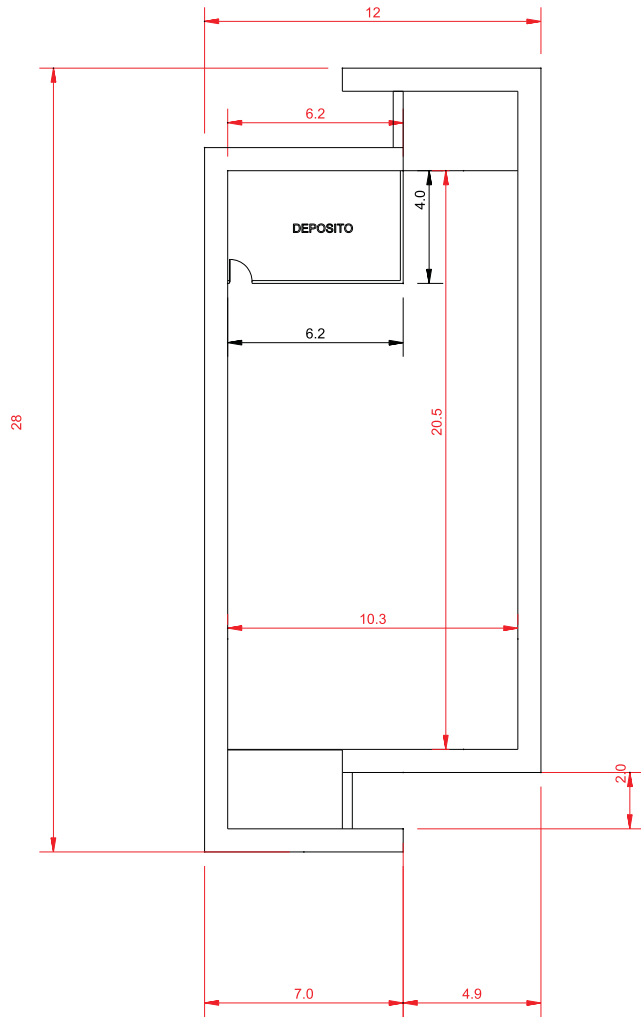

DEPOSITO

