

20,576 m
15,432 m
30,864 m

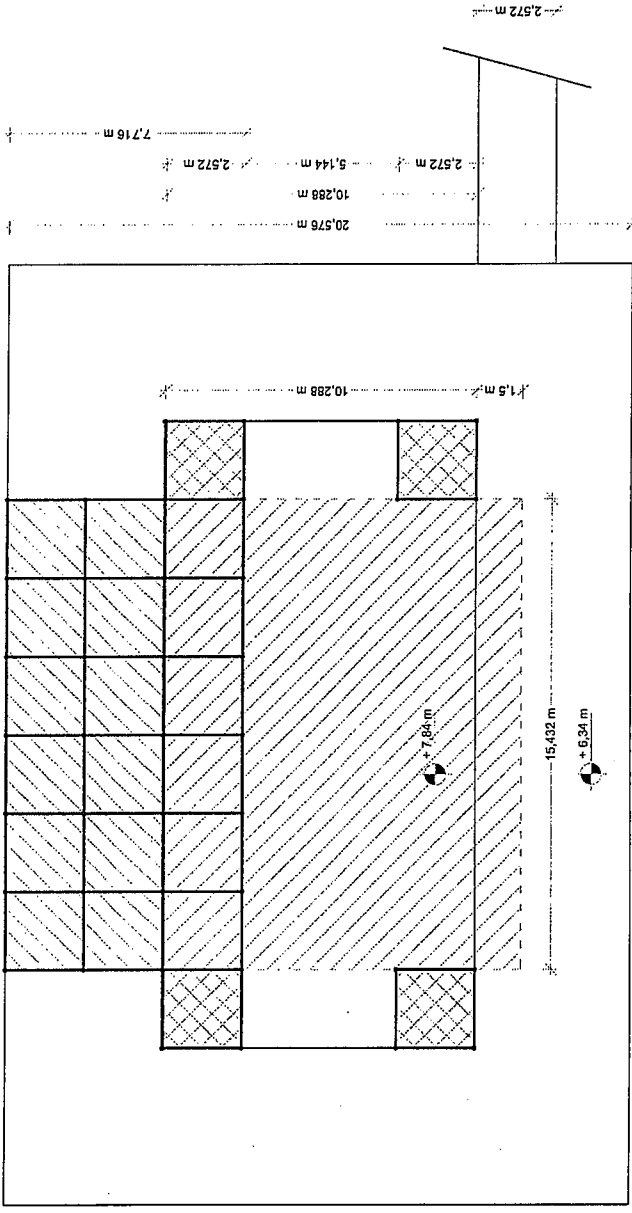

608

PLANTA - cubiertas / stacks

- TORRES ESTRUCTURA SOLA / SIN REVESTIR
- SUPERFICIE CUBIERTA
- AREAS DE TRABAJO

HOJA nº 1

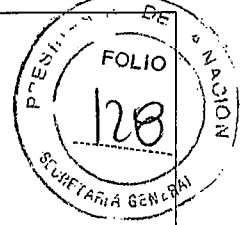

		 TECNÓPOLIS		 UNIDAD EJECUTORA BICENTENARIO		 Presidencia de la Nación		
		PLANO ESCENARIO Nº 1		COMIT	OBRA	RUBRO	ETAPA	PLANO
				TEC	GR	PA	E1	01
				DIB	REV	VERS	E-1	
				FECHA		ESCALA		
				26/04/11				
				APTO PARA LICITAR				

0 1 2 SI ESTA BARRA NO MIDE 2 cm. EL PLANO NO ESTA EN ESCALA

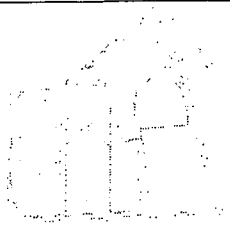

TECNÓPOLIS



UNIDAD EJECUTORA
BICENTENARIO



Presidencia de la Nación

PLANO
ESCENARIO
Nº 1

COMIT	OBRA	RUBRO	ETAPA	PLANO
TEC	GR	PA	E1	01
DIB	REV	VERS	V1	
FECHA				26/04/11
ESCALA				E1-2
APTO PARA LICITAR				

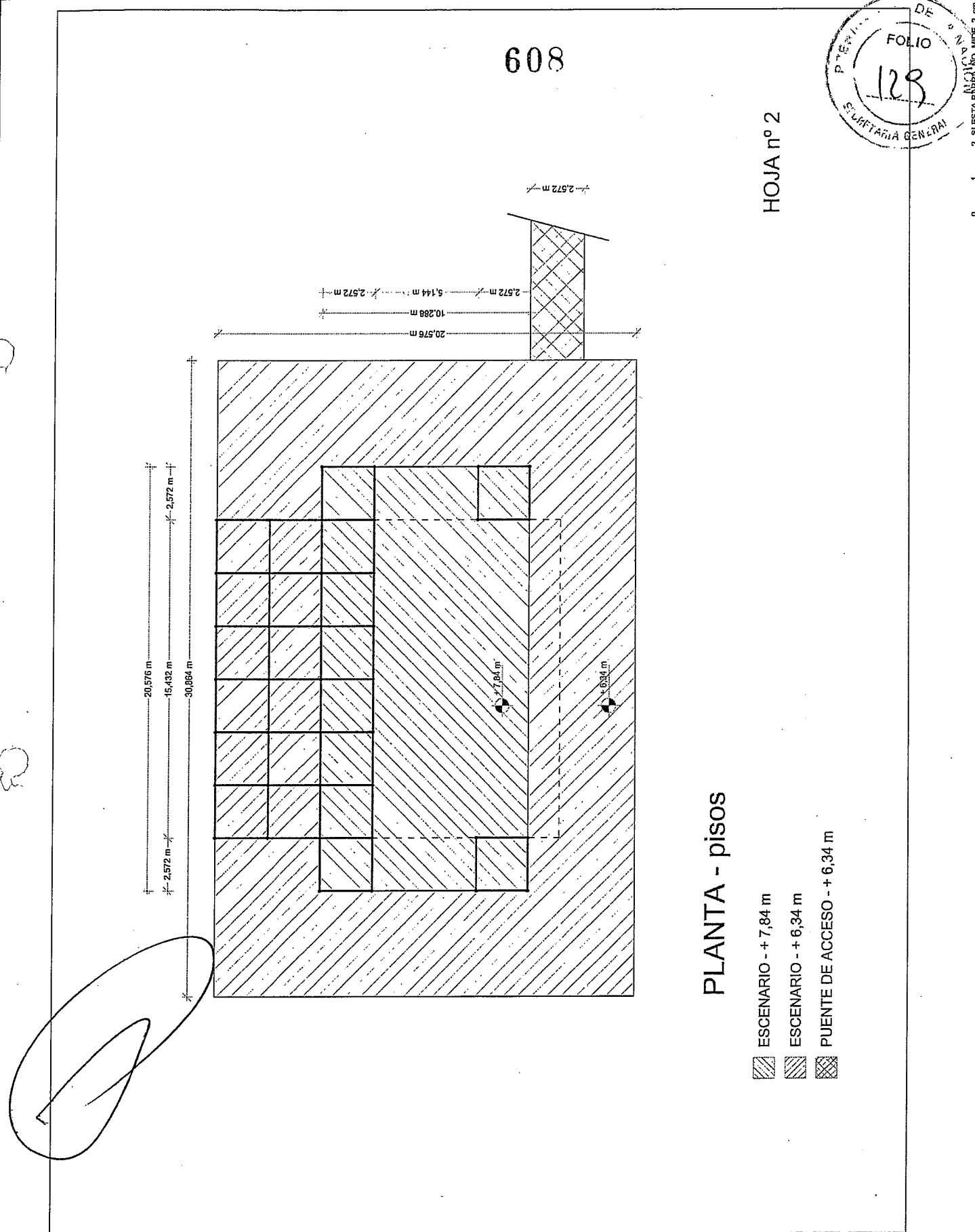



608

HOJA nº 2



2 SI ESTA BARRA NO MIDE 2 CM
EL PLANO NO ESTA EN ESCALA

PLANTA - pisos

-  ESCENARIO - + 7,84 m
-  ESCENARIO - + 6,34 m
-  PUENTE DE ACCESO - + 6,34 m

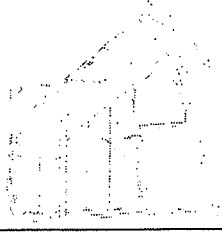

TECNOPOLIS

UNIDAD EJECUTORA
BICENTENARIO

Presidencia de la Nación

PLANO
ESCENARIO
Nº 1

COMIT	OBRA	RUBRO	ETAPA	PLANO
TEC	GR	PA	E1	01
DIB	REV	VERS	V1	
FECHA				26/04/11
ESCALA				APTO PARA LICITAR

E1-3

608

HOJA nº 3

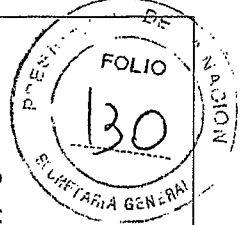

0 1 2 SI ESTA BARRA NO MIDE 2 CM. EL PLANO NO ESTA EN ESCALA

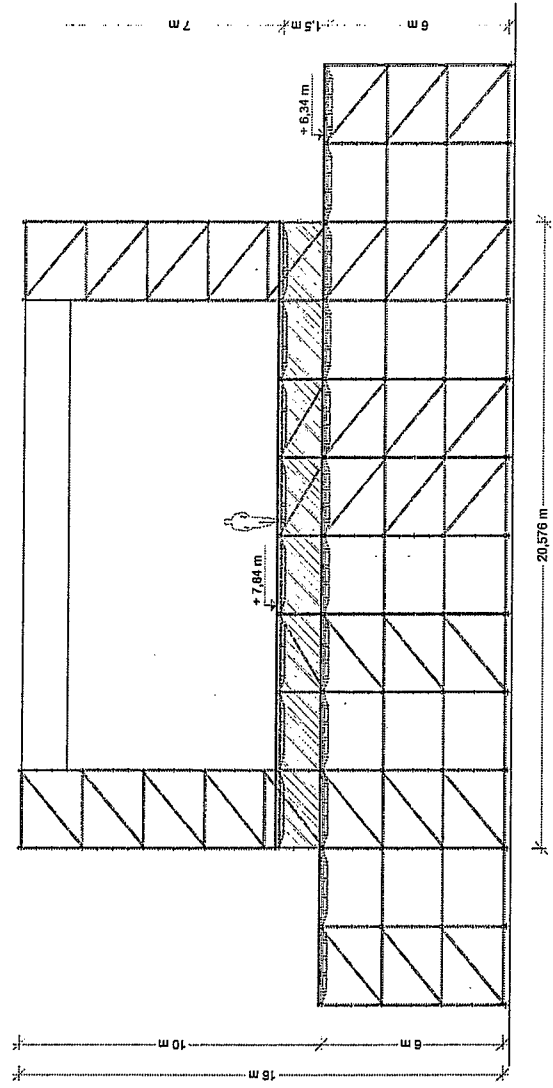

VISTA FRENTE

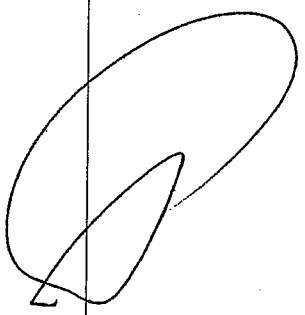

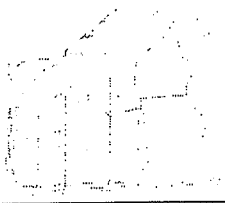

TECNOPOLIS
UNIDAD EJECUTORA
BICENTENARIO

Presidencia de la Nación

PLANO
ESCENARIO
N° 1

COMIT	OBRA	RUBRO	ETAPA	PLANO
TEC	GR	PA	E1	01
DIB	REV	VERS	V1	
FECHA				ESCALA
26/04/11				
APTO PARA LICITAR				E-4

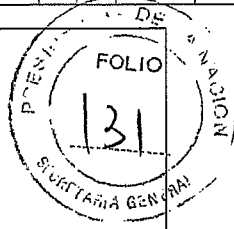

SI ESTA BARRA NO MIDE 2 cm.
EL PLANO NO ESTA EN ESCALA



HOJA n° 4

CORTE TRANSVERSAL

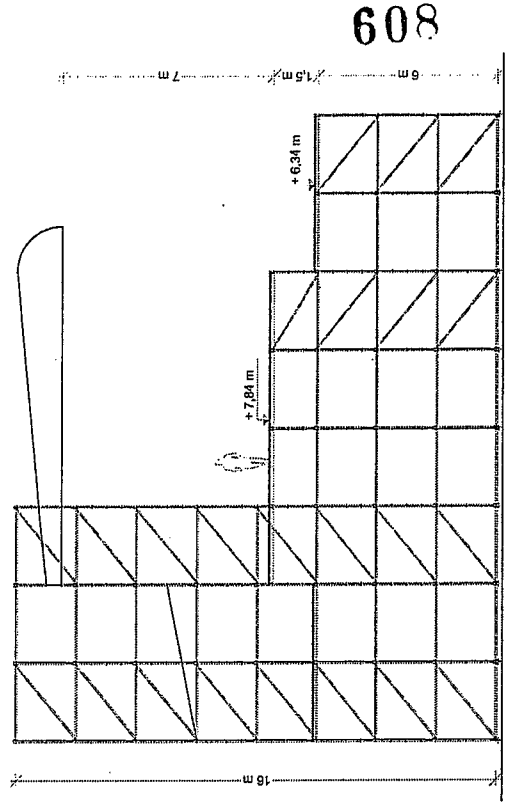

VISTA LATERAL

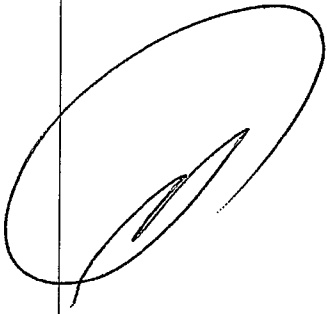
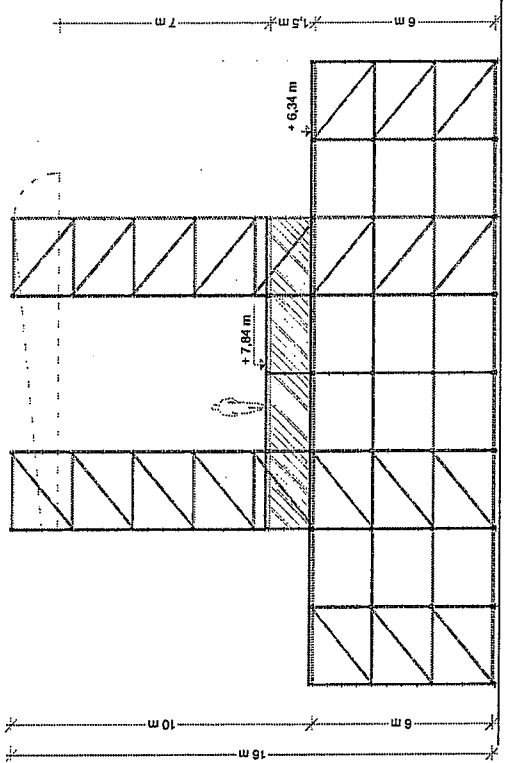

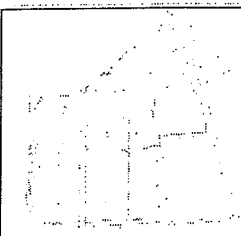

TECNÓPOLIS

UNIDAD EJECUTORA
BICENTENARIO

Presidencia de la Nación

PLANO
ESCENARIO
Nº 2

COMIT	OBRA	RUBRO	ETAPA	PLANO
TEC	GR	PA	E1	01
DIB	REV	VERS	V1	E2-1
FECHA				ESCALA
26/04/11				
APTO PARA LICITAR				



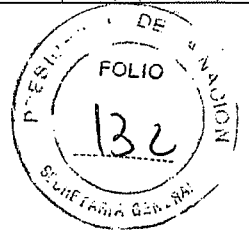

608

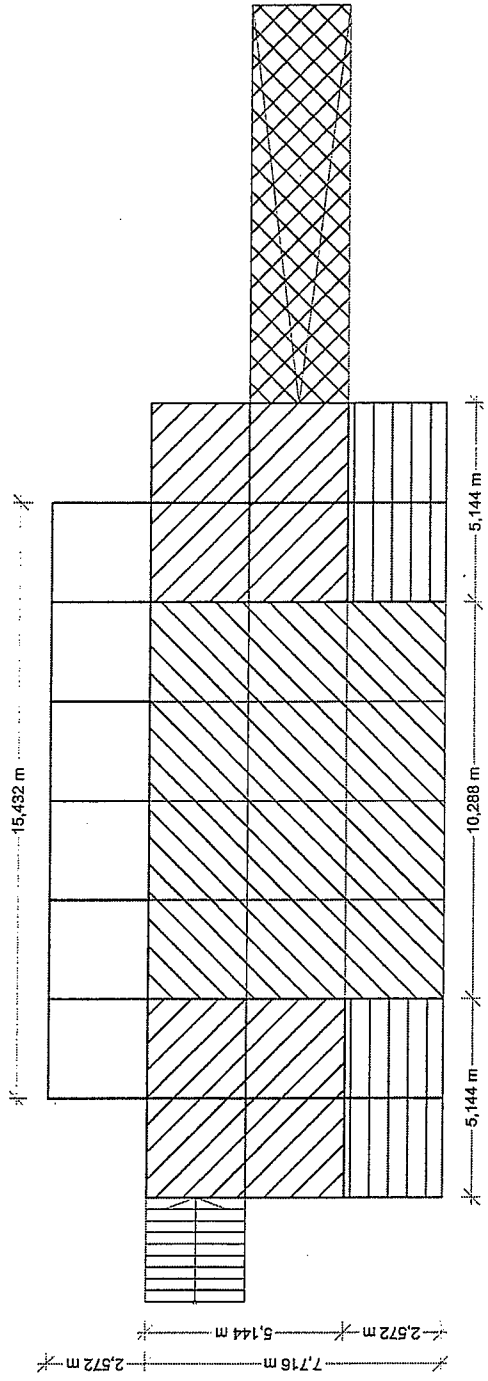

SI ESTA BARRA NO MIDE 2 cm.
EL PLANO NO ESTA EN ESCALA



PLANTA - pisos

-  ESCENARIO
-  AREAS DE TRABAJO
-  AREAS DE SONIDO
-  ESCALERA
-  RAMPA

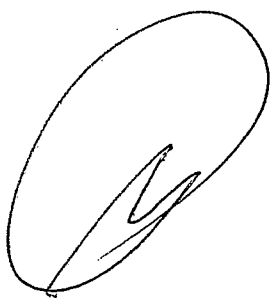

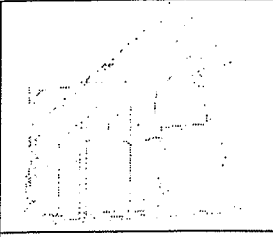

TECNÓPOLIS

UNIDAD EJECUTORA
BICENTENARIO

Presidencia de la Nación

PLANO

ESCENARIO
Nº 2

COMIT	OBRA	RUBRO	ETAPA	PLANO
TEC	GR	PA	E1	01
DIB	REV	VERS	V1	E2-2
FECHA	ESCALA	APTO PARA LICITAR		
26/04/11				

608

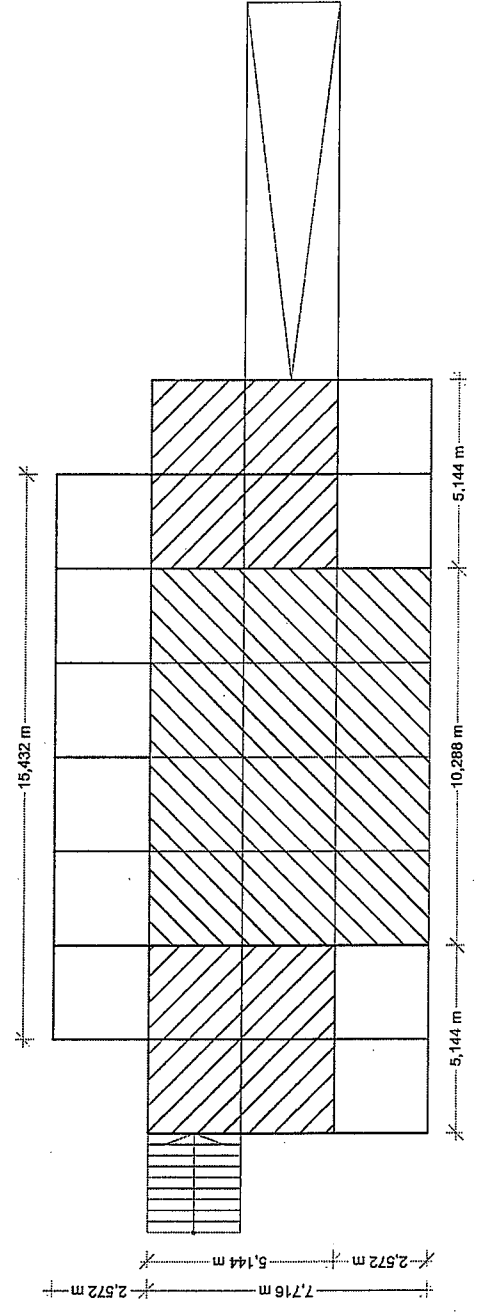

PLANTA - cubiertas

- ESCENA
- AREAS DE TRABAJO

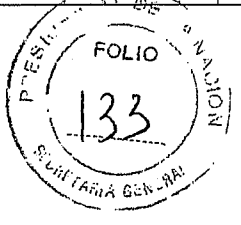

0 1 2
SI ESTA BARRA NO MIDE 2 CM.
EL PLANO NO ESTA EN ESCALA



TECNÓPOLIS
UNIDAD EJECUTORA
BICENTENARIO

Presidencia de la Nación

PLANO
ESCENARIO
N° 2

COMIT	CBRA	RUBRO/ETAPA	PLANO
TEC	GR	PA	E1 01
DIB	REV	VERS	E2-3
FECHA			ESCALA
26/04/11			V1
APTO PARA LICITAR			

608



0 1 2
SI ESTA BARRA NO MIDE 2 CM.
EL PLANO NO ESTÁ EN ESCALA

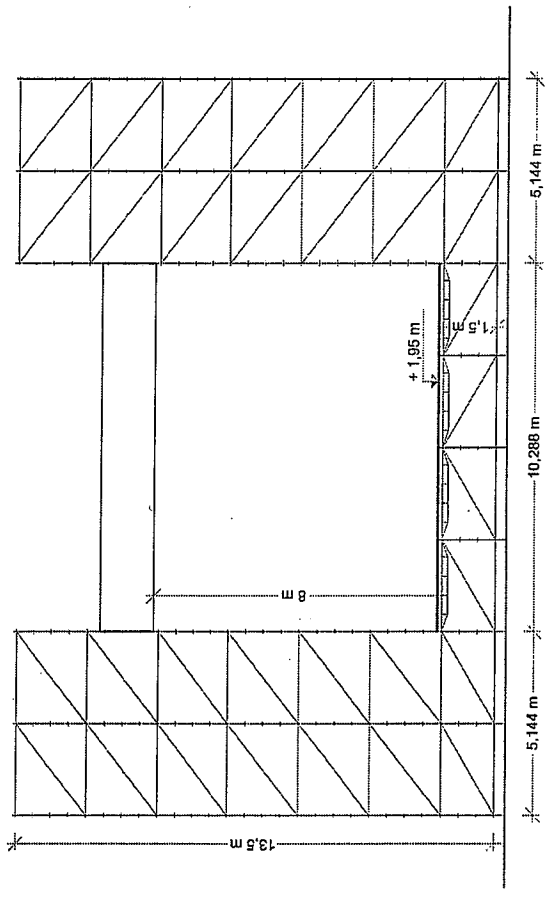

VISTA FRENTE

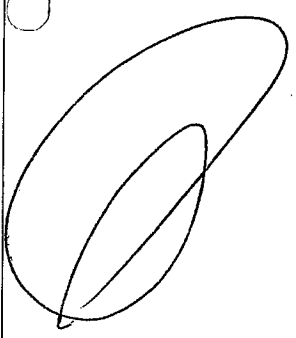

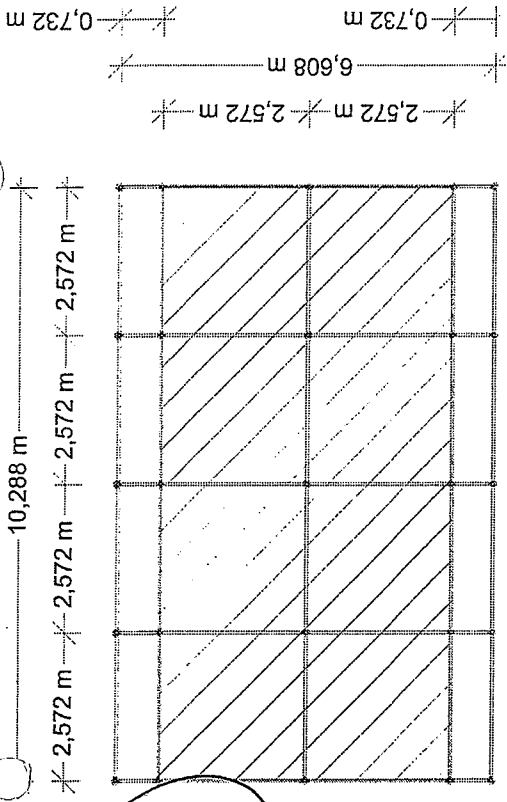

PLANTA

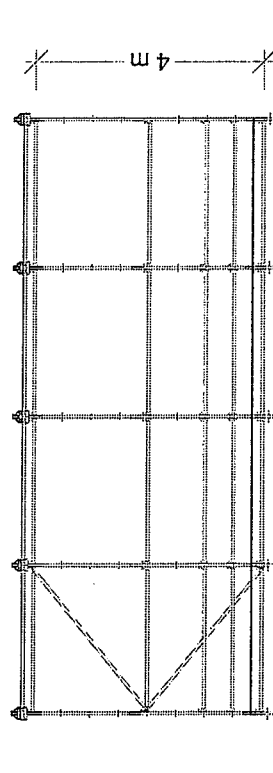

VISTA LATERAL

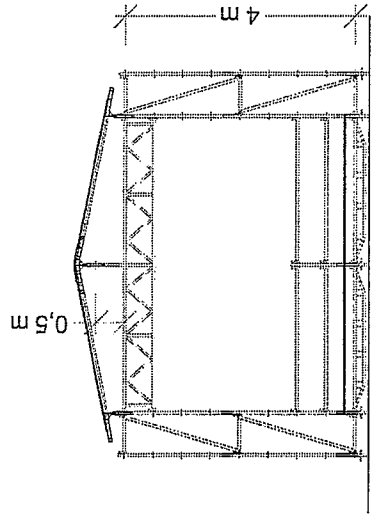

VISTA

608

FOLIO
135
P. E. N. O. C. A. N. A.
SECRETARIA GENERAL

NO ESCALA
SI ESTA BARRA NO MIDE 2 cm.
EL PLANO NO ESTA EN ESCALA

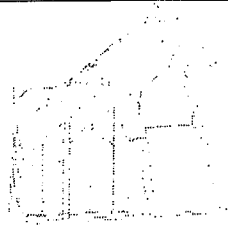

TECNÓPOLIS
UNIDAD EJECUTORA
BICENTENARIO
Presidencia de la Nación

COMIT. OBRA		RUBRO	ETAPA	PLANO
TEC	GR	PA	E1	01
IDIB	REV	VERS	V1	
FECHA				ESCALA
26/04/11				
MANGRULLO				M-1
APT. PARA LICITAR				

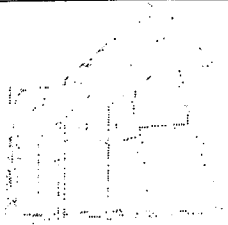

TECNÓPOLIS

UNIDAD EJECUTORA
BICENTENARIO

Presidencia de la Nación

PLANO
ESTRUCTURA
PANTALLA A

COMIT	OBRA	RUBRO	ETAPA	PLANO
TEC	GR	PA	E1	01
DIB	REV	VERS	V1	
FECHA	ESCALA			
26/04/11				

P-A

APTO
PARA
LICITAR

608



0 1 2
SI ESTA BARRA NO MIDE 2 CM.
EL PLANO NO ESTÁ EN ESCALA

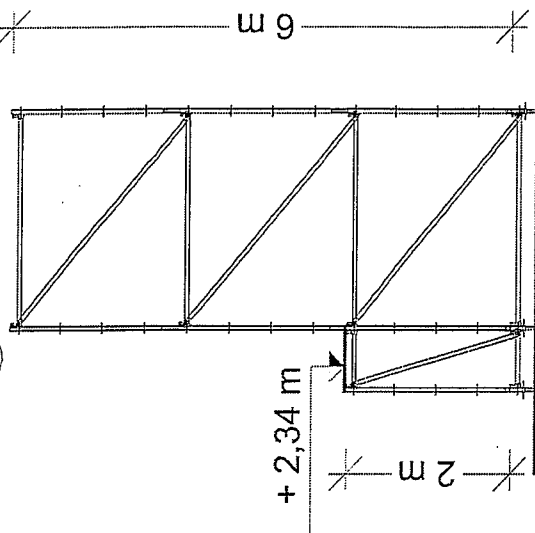

CORTE

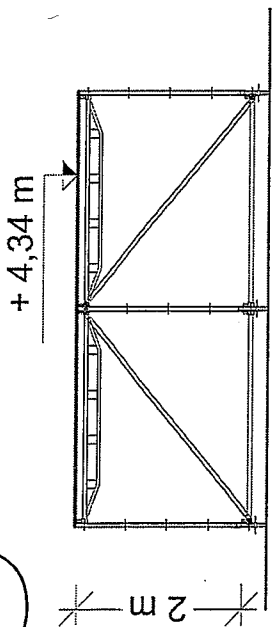

FRENTA

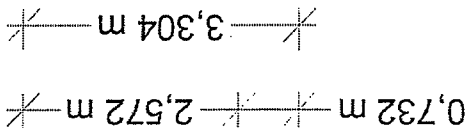

PLANTA

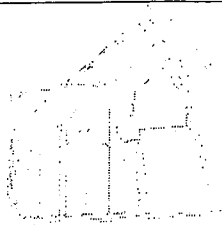

TECNÓPOLIS



UNIDAD EJECUTORA
BICENTENARIO



Presidencia de la Nación

PLANO
ESTRUCTURA
PANTALLA B

COMIT	OBRA	RUBRO	ETAPA	PLANO
TEC	GR	PA	E1	01
DIB	REV	VERS	V1	
ESCALA				P-B
FECHA				APTO PARA LICITAR
26/04/11				

608



2. SI ESTA BARRA NO MIDE 2 CM. EL PLANO NO ESTA EN ESCALA.

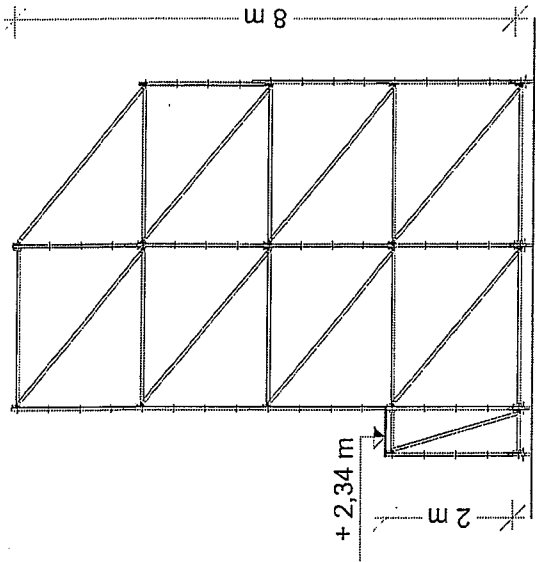

CORTE

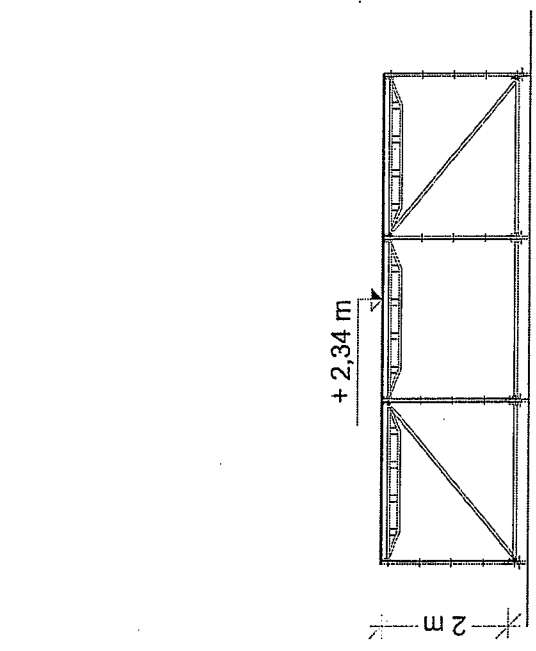

FRENTE

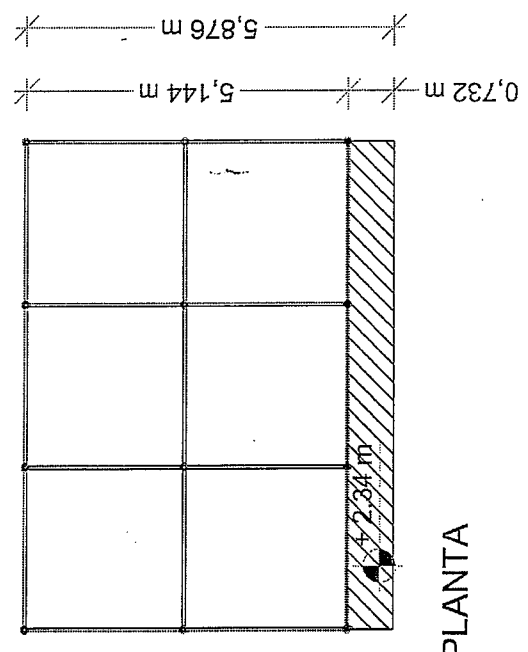

PLANTA

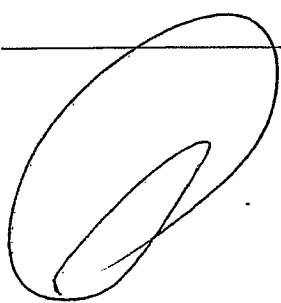

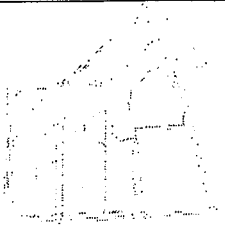

TECNÓPOLIS

UNIDAD EJECUTORA
BICENTENARIO

Presidencia de la Nación

PLANO
ESTRUCTURA
PANTALLA C

COMIT OBRA	RUBRO	ETAPA	PLANO
TEC GR	PA	E1	01
REV	VERS	V1	
FECHA	26/04/11		
ESCALA			
P-C2			
APTO PARA LICITAR			

608

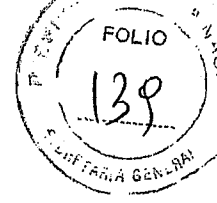

2 SI ESTA BARRA NO LIGADA 2 CM EL PLANO NO ESTA EN ESCALA

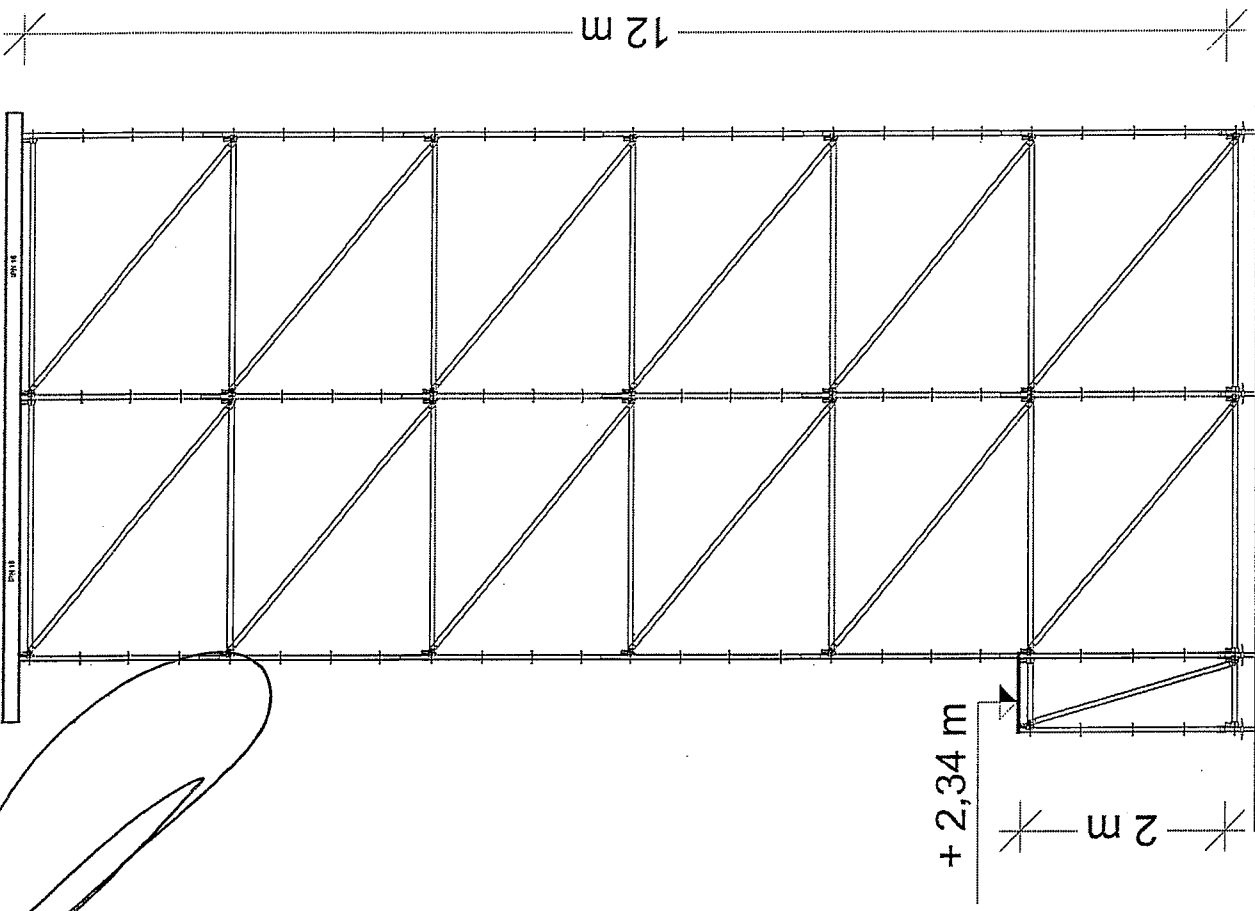

CORTE